

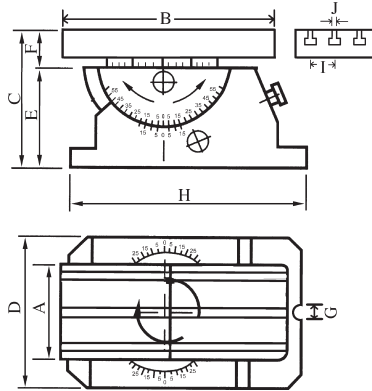

Precision Universal Angle Vise

NEW



- 1.PRECISION GROUNDED.
- 2.RIGID DESIGN.
- 3.THE TABLE CAN SWIVEL 360°, AND TILTS 45°
- 4.IT CAN PUT TOOL MAKER VISE VMV-TYPE VDV-TYPE OR 3 JAW CHUCK FOR CLAMPING
5. THE GRADUATION FOR ACCURATE READING

ORDER NO.	A	B	C	D	E	F	G	H	I	J	G.W.	CODE NO.
VUA-408	100	200	125	110	75	50	16	180	30	12	14	2003-055
VUA-510	126	250	125	110	75	50	16	180	40	12	16	2003-056



Tool Makers Vise

Material:SKS2
 Hardness:HRC 58°-60°
 Squareness:With 0.005m/m

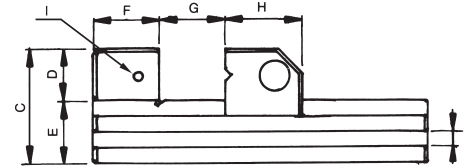
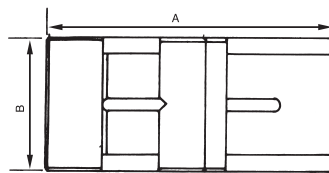
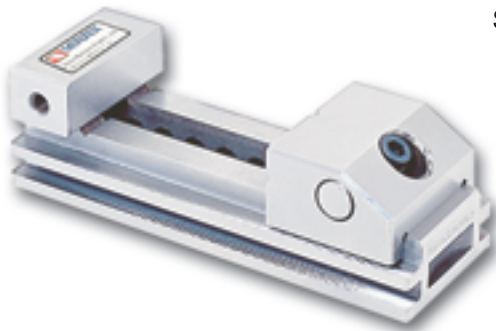

ORDER NO.	A	B	C	D	E	F	G	H	I	J	N.W.	CODE NO.
VC20	135	48	42	20	22	23	62	40	M6	5X7	2kg	2003-070
VC25	160	70	62	30	32	33	80	45	M6	8X7	3kg	2003-071
VC30	175	73	65	32	33	35	95	45	M6	8X7	4kg	2003-072



Tool Makers Vise

Material:SKS2
 Hardness:HRC 58°-60°
 Squareness:With 0.005m/m

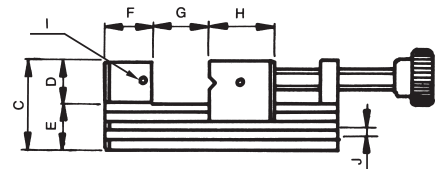
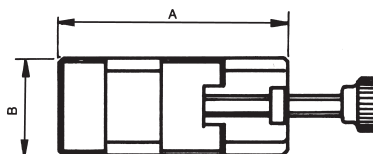
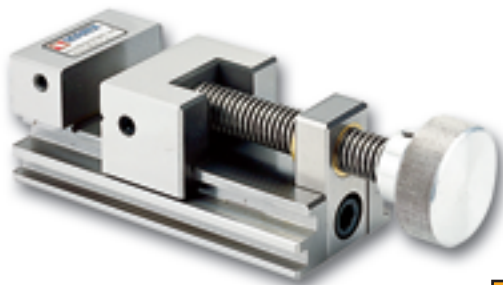

ORDER NO.	A	B	C	D	E	F	G	H	I	J	N.W.	CODE NO.
V-VE20	90	60	50	25	25	25	35	30	M5	6X6	1.6kg	2003-080
V-VE25	160	70	62	30	32	33	80	45	M6	8X7	4kg	2003-081
V-VE30	175	73	65	32	33	35	95	45	M6	8X7	5.5kg	2003-082